



# DaWei Induction Heating Machine Co.,Ltd

Website: <http://www.gpgyjr.com.cn>

E-mail: [inductionheating@gpgyjr.com.cn](mailto:inductionheating@gpgyjr.com.cn)

# Coil Design and Theory

# Coil Design & Theory

Basic Points to consider:

- Success is directly dependant on proper design of the Inductors (work coils).
- The inductor coil itself is only a part of the generator output system
- The same principles of design must be applied to the leads which connect the coil to the output terminals of the generator or remote heating station.

# Coil Design & Theory

## **Inductors** for high frequency induction heating

- Usually referred to as heating coils
- Can be made in a large variety of types and styles
  - Depends on the shape of the metal surface to be heated
- Their design must follow certain principles to achieve maximum efficiency.



# Coil Design & Theory



## Various Coil Configurations

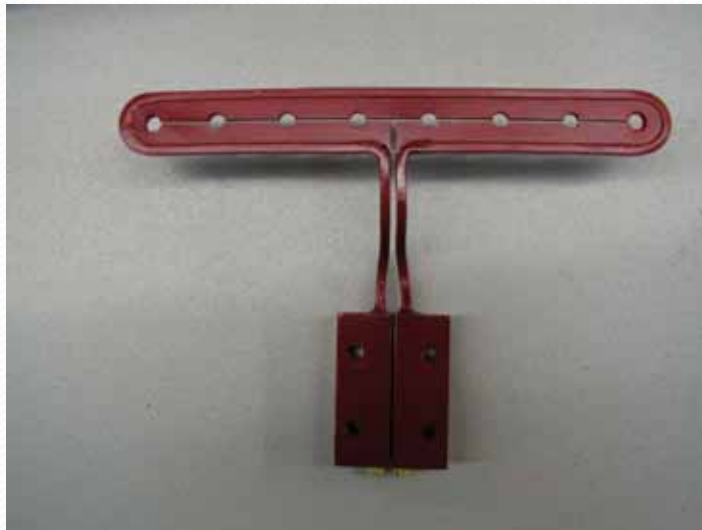

# Coil Design & Theory

The induction coil quickly raises the temperature of a work piece by means of a high frequency current which passes through the coil, as shown in Fig. 1.

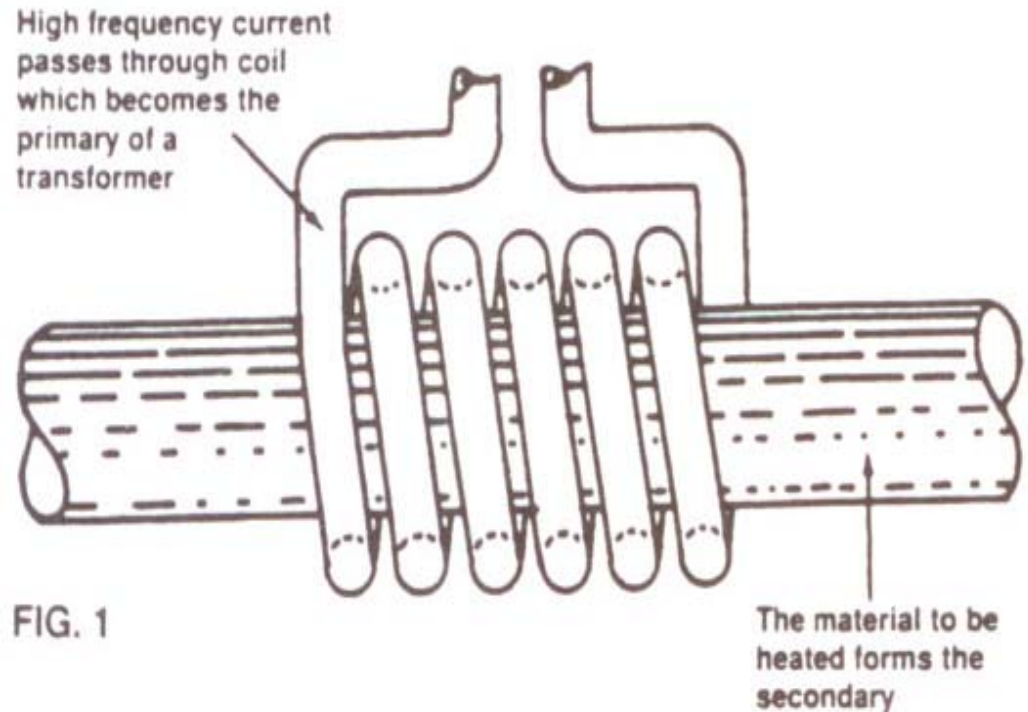

## Coil Design & Theory

Induction coils may be either of multi-turn design, or in the form of a single-turn coil as shown in Fig. 2, the latter often being termed a solid- inductor.

In either case, copper is invariably used in their construction, and cooling by means of water is absolutely essential.

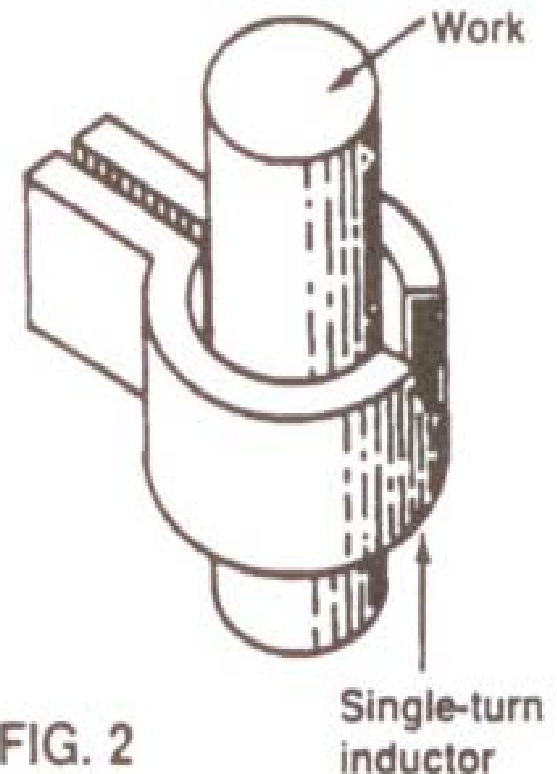



# Coil Design & Theory

The path of magnetic flux in cylindrical coils is shown in Fig. 3.

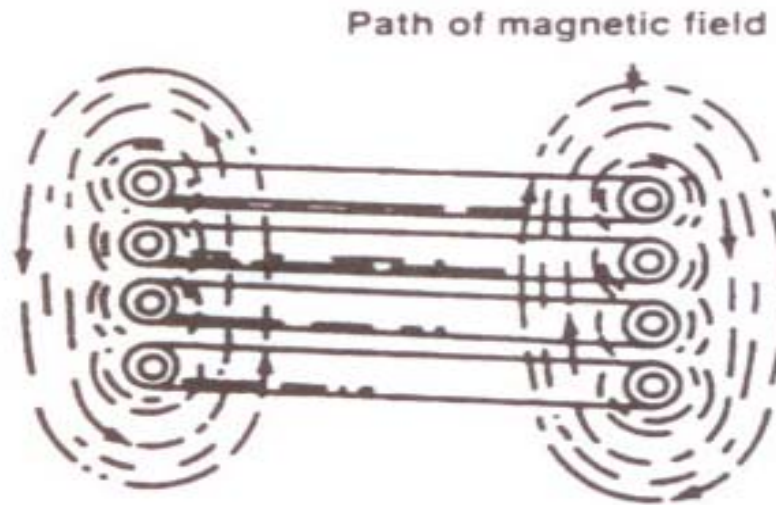

FIG. 3

The direction of the magnetic lines is determined by the direction of the current as it flows through the inductor coil.



# Coil Design & Theory

Heating of metal parts is the result of internal energy losses within the material being treated, which causes the temperature to rise.

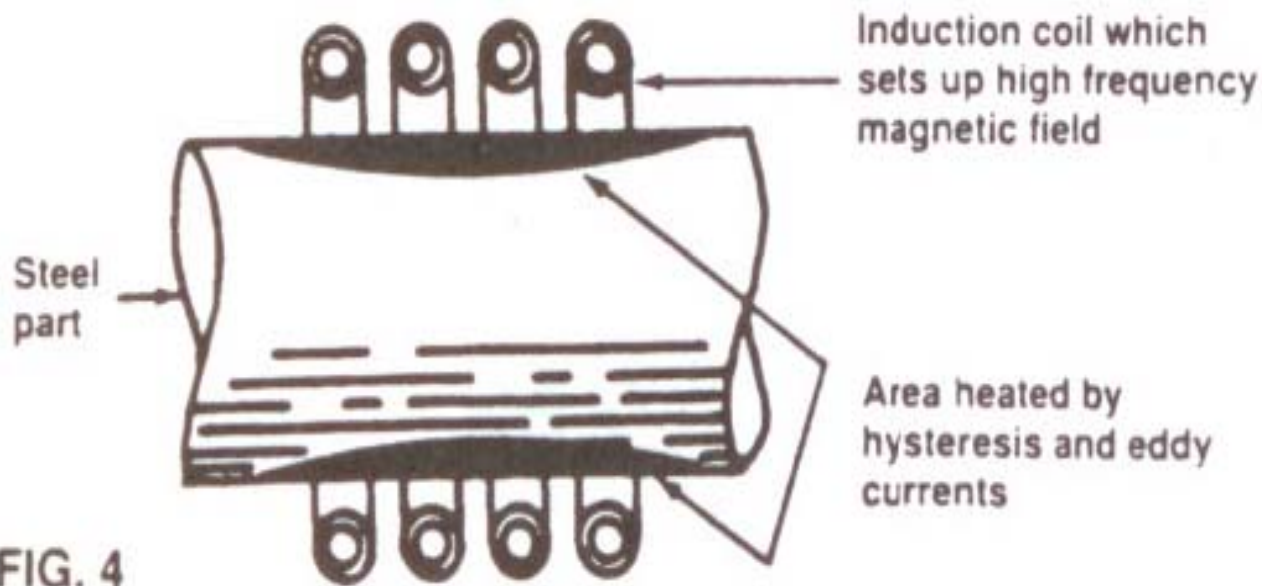

# Coil Design & Theory

- Magnetic fields occur in the area surrounding the coil, and are stronger next to it than at any distance away from it
- Placing the work piece close to the coil maximizes the heat energy generated.
- The strength of the field varies inversely with the square of the distance between the work and the coil.
  - distance between coil and work piece will have a direct relation to the amount of heat generated in a work piece.

## Coil Design & Theory

Fig. 5. shows two single-turn coils. One has a close coupling and the other a loose coupling.

Usually, a close coupling from  $3/32$ " to  $1/8$ " will be satisfactory for outer surface heating where a thin skin heat is desired.

A wider coupling will require more time to generate the heat and its depth will be greater.

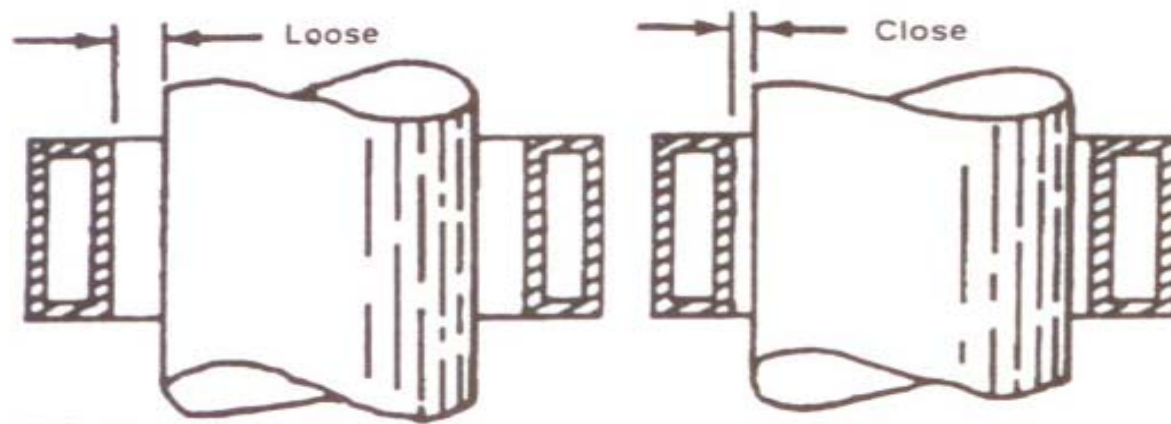

FIG. 5



## Coil Design & Theory

When multi-turn coils are closely coupled to a workpiece, there is a tendency for the eddy-currents to create a heat pattern matching the coil's helix.

The wider the pitch of the coil, the more pronounced this pattern will be.

When the coil is more loosely coupled, that is at a greater distance from the surface to be heated, the stream of eddy currents spreads over a wider area.



# Coil Design & Theory

A wide variety of shapes is possible when making multi-turn coils of copper tubing.

The most common is a cylindrical coil, which is suited to surface heating of shafts and round parts.

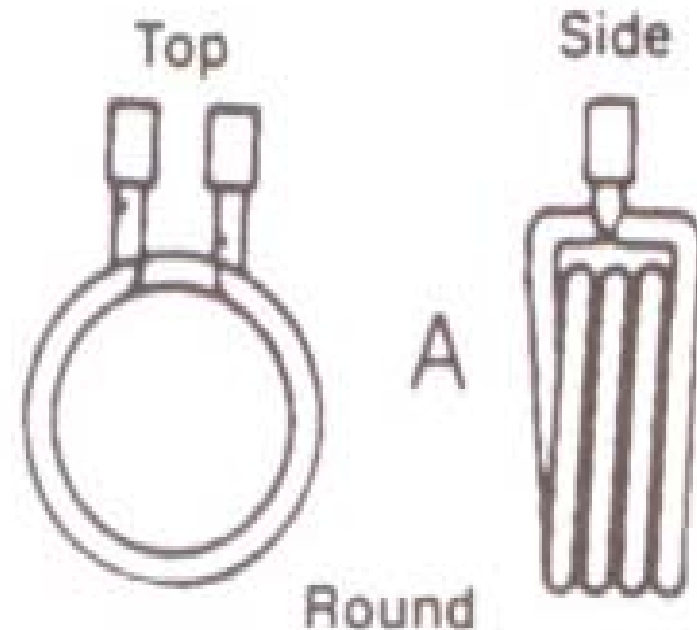

# Coil Design & Theory

The pancake coil shown below is used for heating flat surfaces.

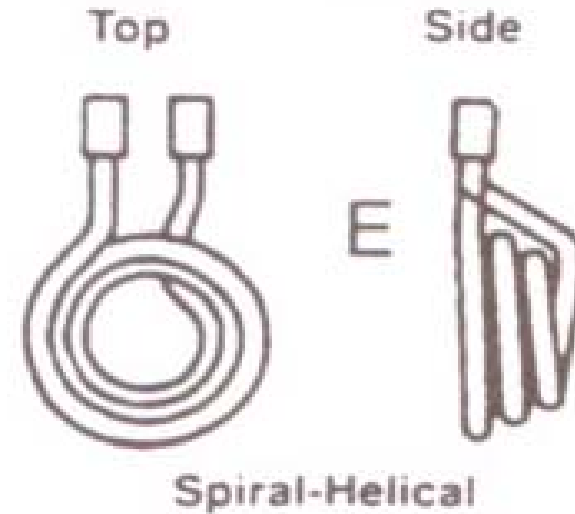
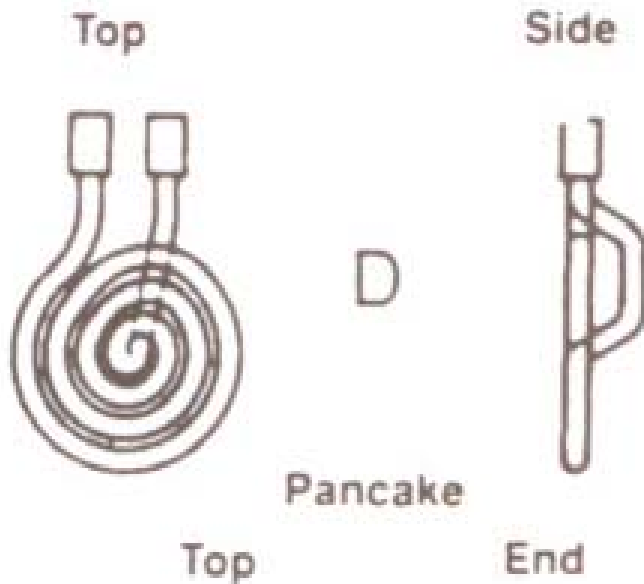

The spiral-helical coil shown above is used for heating conical surfaces.

## Coil Design & Theory

- Copper tube coils are usually made of tubing, ranging from 1/8" to 3/8" in diameter.
- The 1/8" size should be used very sparingly, however, because the flow of cooling water is likely to be too small to prevent over-heating.



# Coil Design & Theory

Round copper tubing can be used for many types of coils, as shown in “A”,

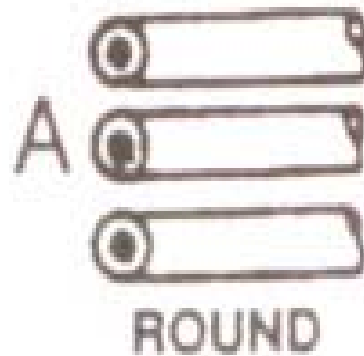

It is preferable to flatten the tubing as illustrated in “B”.

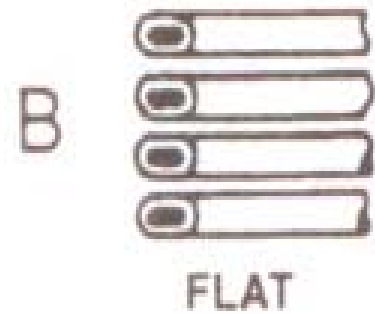



## Coil Design & Theory

Another very practical form is the square or rectangular shape shown in “C”.

It also is possible to use a larger diameter tubing, such as 5/8" or 3/4". as shown at “D”, and to produce a flat coil similar to a solid Inductor previously mentioned.

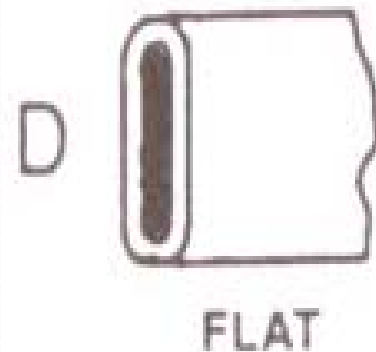
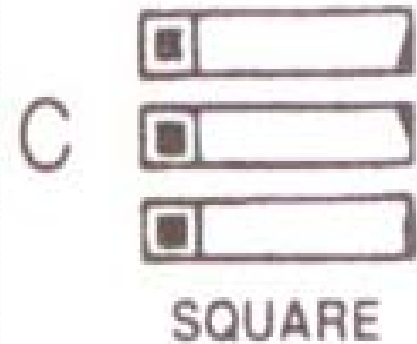

## Coil Design & Theory

SOLID-TYPE induction coils are made of rolled copper plate and can be arranged for single or multiple operations.

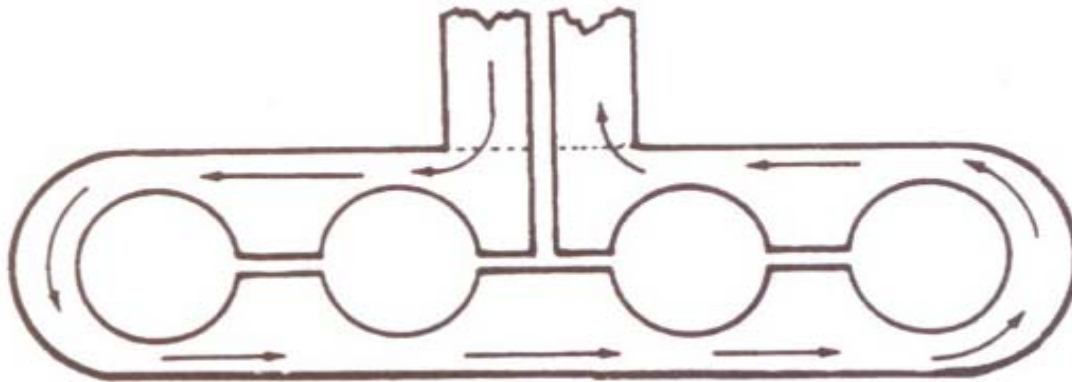

FIG. 14

## Coil Design & Theory

The coil shown in Fig. 14 is made of a thick copper plate, bored to suit the diameter of the part. Two connecting blocks are brazed to this plate, then the plate is sawed out, as shown, so the high-frequency current will follow the path of the arrows-coming in at one block, and going out at the other.

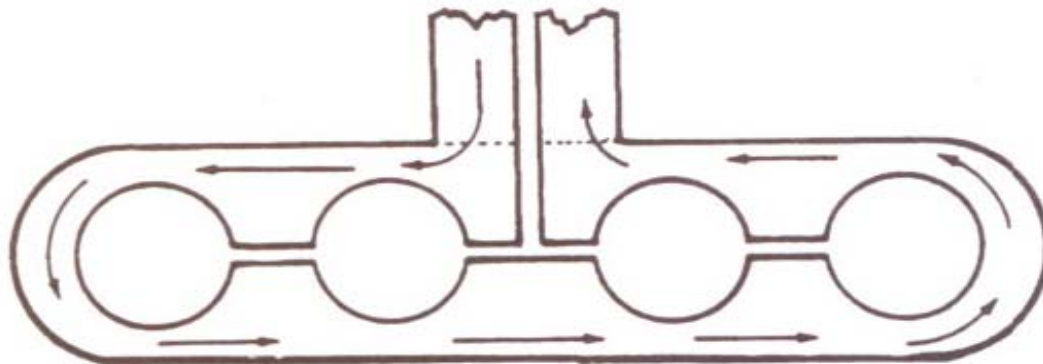

FIG. 14



## Coil Design & Theory

Usually, when heating a tapered surface, the coil is made to conform with the taper, although exceptions may be considered as in Fig 19,

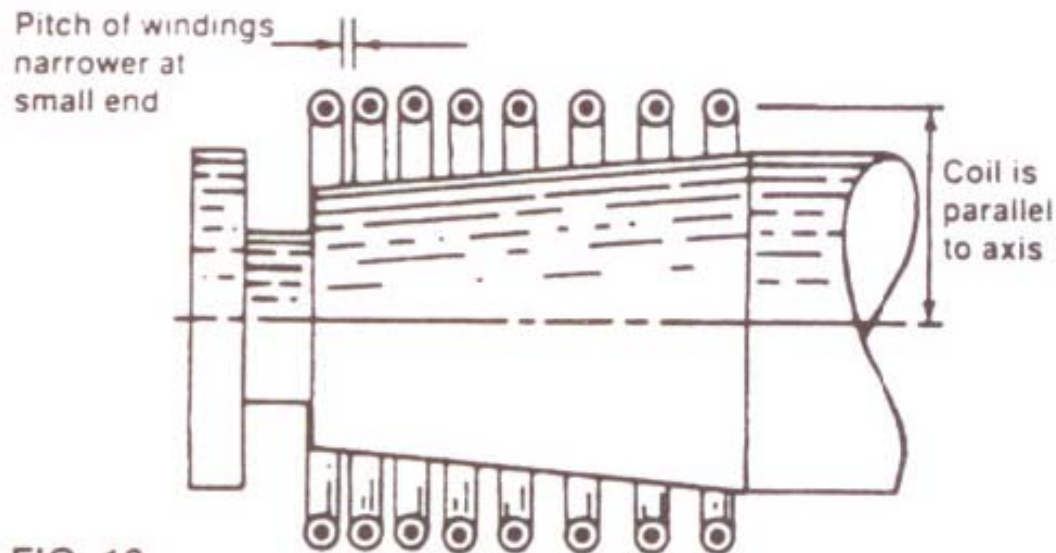

FIG. 19